

All Porpoise Actions

Find action designs in the Waves however there are more beautiful actions to showcase!

- [Songsheet](#)
- [Poo Themed actions!](#)
- [Dirty Water Scrubbers](#)
- [Make a mock Newspaper](#)
- [Make a Fishhead or Fish Mask](#)
- [Dirty Water Coolers and Mock Sewage Pipes](#)
- [Face-in-the-Hole boards](#)
- [Dirty Water Crime Scene](#)
- [Making Art with Withy](#)

Songsheet

PDF version for downloading and printing [here](#).

With thanks to Suffolk, whose MP is Therese Coffey, but you can insert your own/relevant MP surname/water authority/organisation...

To the tune of 'My Bonnie Lies Over the Ocean'

(soundcloud link [here](#))

The sewage flows into the river,
The sewage flows into the sea
The sewage flows into the [Deben] [insert own river name here, or just use word 'ocean']
And the blame lies with Therese Covey

Bring back, bring back, oh bring back clean rivers and seas and seas,
Bring back, bring back, oh bring back clean rivers and seas.

The runoffs as bad as the sewage,
With pesticides killing off bees.
They kill off aquatic invertebrates,
And the blame lies with Therese Coffey.

Bring back, bring back, oh bring back clean rivers and seas and seas,
Bring back, bring back, oh bring back clean rivers and seas.

To the tune of 'Hi Ho Silver Lining'

(soundcloud link [here](#))

By the rivers all around the country
You should hold your breath
If you ever dare try to swim there
You are risking death
In the streams that feed the rivers
You can count the turds
As our sewage is no longer filtered
While MPs ignore our words

Chorus:

And at high tide I feel like crying
As all around our coast
We see aquatic life is dead & dying
And so we make this fuss
Because it's obvious

The Tories voted for pollution
In a solid block
But come the next election
They could get a shock
Coffey, Hunt & Poulter,
Churchill, Aldous too (Insert own MPs here)
Suffolks Conservative MPs,
All voted for more poo!

Chorus:

And at high tide I feel like crying
As all around our coast
We see the scummy crud & crap a-rising
And so we make this fuss
Because it's obvious

Repeat 1st Chorus

Chords for guitars/ukes:

Intro: G G

Verses: G G C C F C G D x 2

Chorus: G G7 C D G G7 C DC G G

The Climate Choir Movement

The [Climate Choir Movement](#) also have some relevant songs that you can use.

Why Wye Wye

[Lyrics](#), [Score](#) and All Parts [Audio](#)

Dirty Water

[Lyrics](#), [Score](#) and All Parts [Audio](#)

For more climate related songs [check out the Music and Performance pages here](#).

Poo Themed actions!

Poo Pouring

A short video of a poo-pouring action from Wave 1.



Rogers Poo Recipe!

- Make some porridge, as you would for breakfast but thinner and more watery.
- Then thicken it up by adding white flour (in cold water) and boiling again till the right consistency achieved. Needs to run slowly down a vertical surface.
- Then add torn bits of kitchen paper and stir in some water-based brown paint.
- There is plenty of scope for variations!!

This action idea could also be a centerpiece for a larger event.

Recce and rehearsal

Practice your pouring ceremony beforehand to be sure it goes right. Most targets will be vertical so practice pouring onto a vertical surface. Use a receptacle such as a squishy plastic bottle to pour from.

Survey the Pouring target beforehand to plan your theatrics, and also to be sure it will cause no lasting damage.

Important Warning - be aware that Poo Pouring on a permeable surface, such as stone, could cause long lasting stains, impossible to clean off on the day. Avoid permeable surfaces due to the possibility of inadvertently causing 'criminal damage'!

Clean up!

It is vital to clean up after your point has been made if you want to avoid any charge of criminal damage!

Bring water and cloths to clean up, and place a piece of carpet beneath the target to catch drippage.

Poo Party



River Creatures Party by Taunton's River Tone but Raw Sewage in the Water turns it into a Poo Party

(Youtube 3 mins)

Brief Action Plan for Sharing

Location - busy park, Saturday morning, polluted River Tone in background.

Props and Costumes - long table so we can all sit behind, in shot. Tablecloth smeared in sewage with banner "Stop the Poo-lution" and "crockery" which is bits of old plastic taken from the river plus "Crisis, What Crisis?" tea-pot.

Guests are wearing animal heads and human colourful clothing to match their creature.

Also at the party are citizen scientists in hazmat suits (under a fiver at builders merchants) with clip boards, testing the river water in jugs on table, which animals are drinking.

Soundtrack

Swimming In It by Beans on Toast

(Youtube 5 mins) - perfect length and really added something.

Whilst it's playing - creatures dance around table, drink lots of river water, eat turd and poo cakes and gradually all die. Citizen scientists express angst and grief. Final scene is a tableau of dead creatures, debris and banners.

Dirty Water Scrubbers

This style theatrical action idea was developed for dirty banks.

Your local issue around water pollution may have a target suitable for a visit from Dirty Water Scrubbers, maybe with the addition of water pollution themed props.

Here's the basics

Dirty Scrubbers outfit (all genders):

Plain leggings and tops, headscarf, curlers, heavy makeup, rubber gloves, filter tipped cigarettes!

Props: cleaning equipment, ideally colourful- if there's a choice then green gold or leopard print!

If you want the full monty with scripts and useful links for resources

How to be a Dirty Scrubber



Make a mock Newspaper

Here are some design ideas for newspapers for an action, we printed them off and glued them to large folded white card to look like a broadsheet.



Examples from the Dirty Water Campaign

Note these images have been generated from the PDF files and reduced in quality to display in Rebel Toolkit

DAILY **DISCHARGE**

THAMES WATER BOSS SHOCK RESIGNATION



Chief Exec quits
as mismanaged debt
riddled utility giant
looks ready to fold.
She pocketed great
bonus but bottles it!
Public anger grows
& government mulls
over rescue package
of disfunctional firm.

Thriving in the age of distractions

People prefer celebrity tittle tattle, conspiracy, culture wars and short term gain, to facing tricky long term questions. As cake mentioned more times than climate change by off-shore billionaire owned media. DON'T LOOK UP!!!



Our rare and precious chalk streams are under threat

FAECAL TIMES

Deep Impact <small>Business world sizes up risks and trends for 2023</small>	One to watch: Shell <small>rolls back net zero commitments, smelt record breaking profits and dividends</small>	Next big gold rush <small>As upstream carbon capture technology while profits soar and runaway climate change sets in</small>
--	---	---

Water bills set to increase by 40% in government plan to make public pay for corporate mismanagement

A docile population snoozes while a cabinet of millionaires hatches cunning plan to hike bills in order to cover their poor governance and shortsighted bad decision making. Meanwhile protest is made illegal and no one notices, in major coup for overall government control. Combined with electoral reform, withdrawing legal aid, banning juries in cases for protesters and increasing powers of police, corporations and private security. With a rigged political system and a compliant media, the rich are set to get richer and it no one can stop them.



UK utilities a no brainer for foreign pension funds, as profits soar due to lack of investment in upgrades. Consistently delivering dividends.

Canadian pension fund and Middle Eastern financiers snort strip UK infrastructure. While other countries pay working for well run water systems. Venture capitalism goes from strength to strength in the UK. Investors eye UK property as the next big funding frenzy opens up due to inflation, interest rates and repressionism. One to watch as the rich get richer while nature and people pay the price in age old states open.

Investors delighted as tax payer set to bail out too big to fail water company.



Global finance summit kicks off. Key note speaker says "Living in a bubble is so much fun. We deserve all the money because we are smarter than you. You are lucky to have us running the show. We are preparing our private islands and armies. Who needs water anyway? Intergalactic rivers and extraordinary large profits are far more interesting than thriving ecosystems. We CAN eat money, stuff the rest of you, if you play ball we may throw you some crumbs"



Water Exec's Sick Bonus Haul

BUMPER BONUS BONANZA !!!!!!!

Cynical Bosses Cyphon Profits amid hosepipe bans , record-breaking leaks and shock river discharges. Maggie Thatchers legacy in tatters as British public sold down the swanny by lax regulation of greedy , profit driven utilities. These foreign owned companies rip off British tax payers and pay top execs fat bonuses while debts pile up in too-big-to-fail water companies.

Apparently BY MIKE BARFIELD

FAR-FROM-FRESHWATER FISH:
A SEWAGE OUTFLOW GUIDE



Make a Fishhead or Fish Mask

From quick and easy to more complex, make a Fishhead or Fish Mask!



How to make a Fishhead

<https://www.youtube.com/embed/OShNHDO89-o?si=PHQ5KA800Rpm1yRk>

You will need:

- Cardboard (boxes including pizza boxes will do - not too thick)

- String or something to measure around your head
- Scissors or a craft knife / scalpel (and cutting board if using a knife)
- Pencil and marker pen
- Stapler- long one if possible
- Masking tape
- Pliers, though not essential
- Newspaper or something to cover the table / floor as protection
- Chalk spray paint
- Chalk paint markers

You can buy chalk spray paint from [Suspectpackage](#) and at the time of buying they were cheaper than [Graff](#). Chalk paint markers can be bought from a variety of places including both outlets above.

How to make a Fish Mask

Designed by Steve Wintercroft

This mask can be built by simply taping the edges together or using the tabs to glue the edges together.

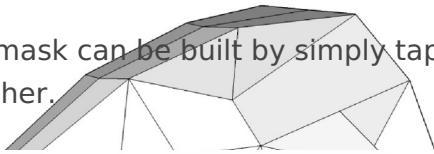

Choose



Untabbed Construction

Choose this construction technique if you are short of time, or are looking for a quick and easy project. Building this mask without tabs is much quicker and although the finished mask will still look awesome it will not be as neat.

Build time approx: 2 hours

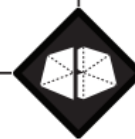

Tabbed Construction

Choose this construction technique if you have plenty of time, are looking for a more substantial project and want to achieve the best possible finish. Building this mask using tabs will take longer but the finished mask is stronger and will look neater.

Building time approx: 4 hours

Materials Required

- [Access to](#) a printer and 16 [sheets of](#) A4 paper or US Letter paper.
- Thin card, the type used in cereal boxes is ideal. Thicker [card](#), such as corrugated card, [does not work well as](#) it will not bend to the detailed folds. The approximate area required is around 5 sheets of flat A3 card.
- Spray mount, Pritt Stick, PVA or similar product that will stick paper to card

Printing Advice

- The templates are 1:1 scale and are intended to be printed at ACTUAL SIZE on either A4 paper (210mm X 297mm) or US Letter paper (8½" X 11"). In your printer setting please select the type of paper that you are printing on but DO NOT SCALE THE TEMPLATES TO FIT THE PAPER.
- I have included a Scale Guideline on the first page of the templates so that you can check the scale. The line should

1. Having printed the templates on paper, trim them roughly to the approximate size, they don't have to be neat. Trimming off the excess paper makes it easier to arrange the templates on the card.

2. If you are working with reclaimed card unfold your boxes so that you have flat sheets to work with, then glue the templates to the card. When you assemble your mask, your templates will be on the inside faces of the mask. A good quality glue stick is cheap and works well for this. Make sure that the templates are well bonded to the card.

3. Cutting



Untabbed Cutting

Cut around the outside of each part. As you will be taping the edges together, you will not need the grey tabs so they can be cut off at this point. The direction of the fold line on the tabs are not important as these are the edges that you will be taping together.



Tabbed Cutting

As you will be using the grey tabs to assemble the mask make sure to only cut along the solid outlines.

4. The fold lines on the templates are marked as either a dashed line representing a valley fold or dashes with dots to represent a mountain fold. This is with the templates on the inside of the mask.

5. Score all of the folds marked on templates with something blunt like an old ball point pen. Scoring weakens the card along the fold lines and helps to keep your folds neat. Score and fold all of your parts.

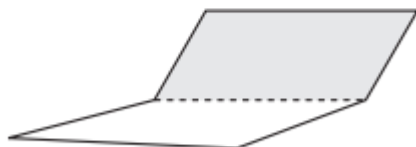

Dashed line represents a valley fold



Dashed line with dots represents a mountain fold

5. Starting with the parts labelled (A) and (B) find two edges with corresponding numbers.

For example edge number 14 joins to edge number 14. The numbers do not need to be completed sequentially. Then follow either the tabbed or untabbed instructions below.

Assembly



Untabbed Construction

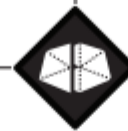
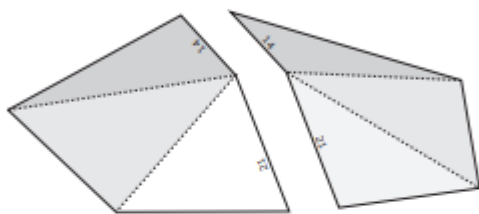

Tabbed Construction

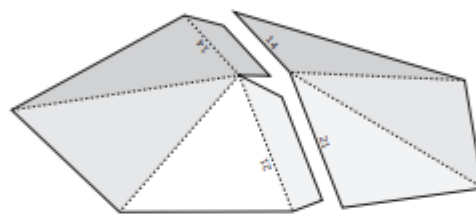

Once you have built the mask, make the head band following the instructions on the final page and tape it to the inside of the mask.

You can paint or decorate your mask in any way that you like.
Have a look at our website or Facebook page for inspiration.

Tag your photos with the hashtag **#wintercraft**
to share them with our community.

If you run in to any problems or have any questions
please check the frequently asked questions on:

www.wintercraft.com

If you still can't find the answer to your questions, then please
send me a message to the address in the contacts below.

Please Note

These designs are protected by copyright law and are intended for your own personal use only. Please use this file to make as many masks as you like for yourself but please don't share or steal the templates, there was a lot of work involved in creating them. If you want to use them for any other reason then please get in touch. Selling items made from our templates is prohibited.

THESE MASKS ARE A PERSONAL CRAFT PROJECT, PLEASE DO NOT USE THEM FOR PROFIT.

Contact Us

I would love to see your finished creations, please share them on our Facebook page:

www.facebook.com/wintercraftmasks

or use the hashtag **#wintercraft**
or Instagram handle **@wintercraft**

Many thanks
and have fun,

Steve

info@wintercraft.com



Scale Guideline

To check the scale is correct, the line below should be 150mm from end to end.

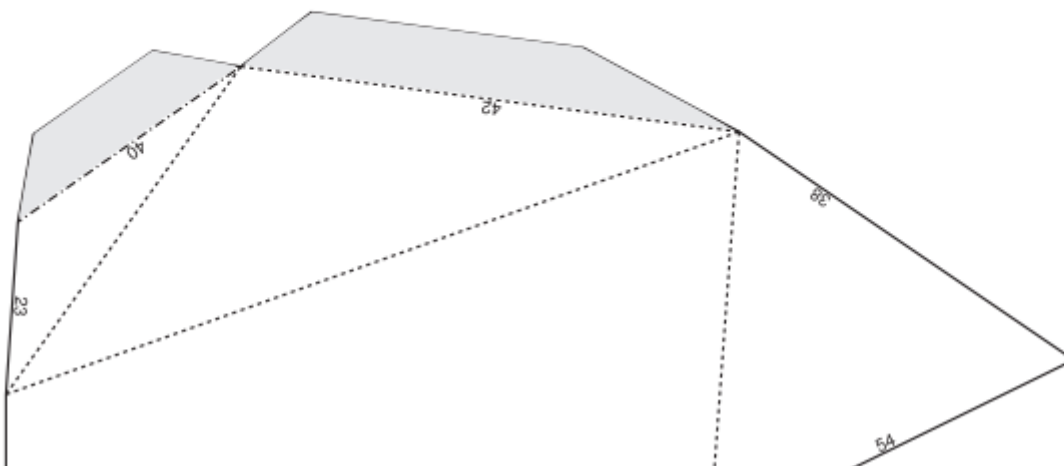

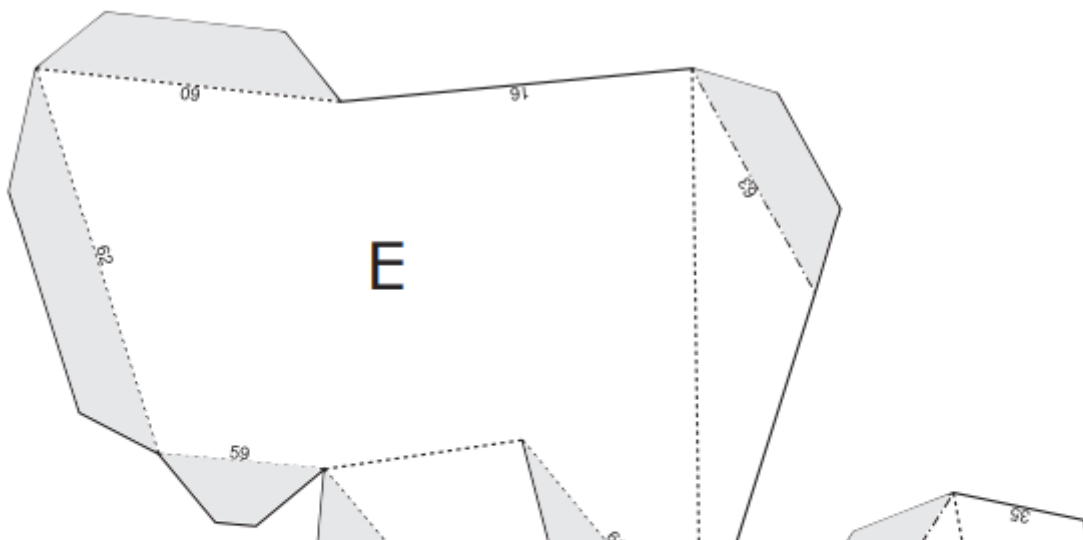
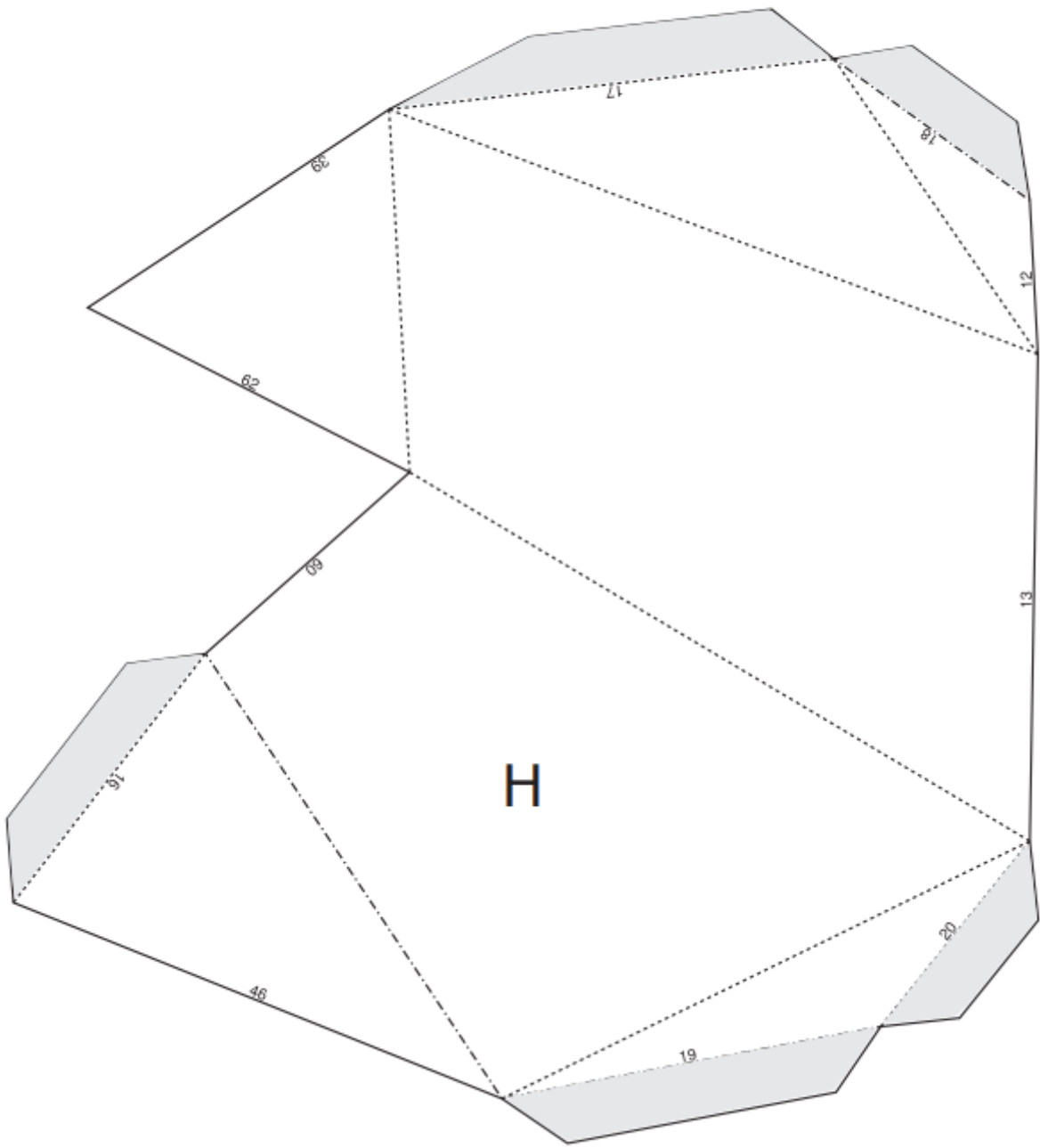

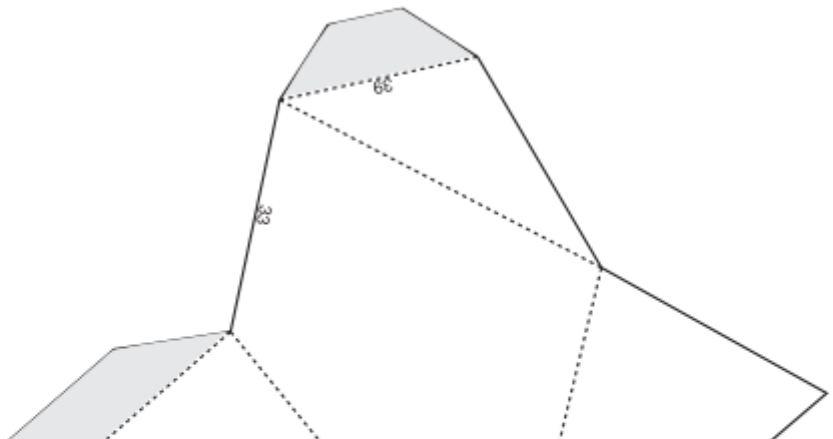
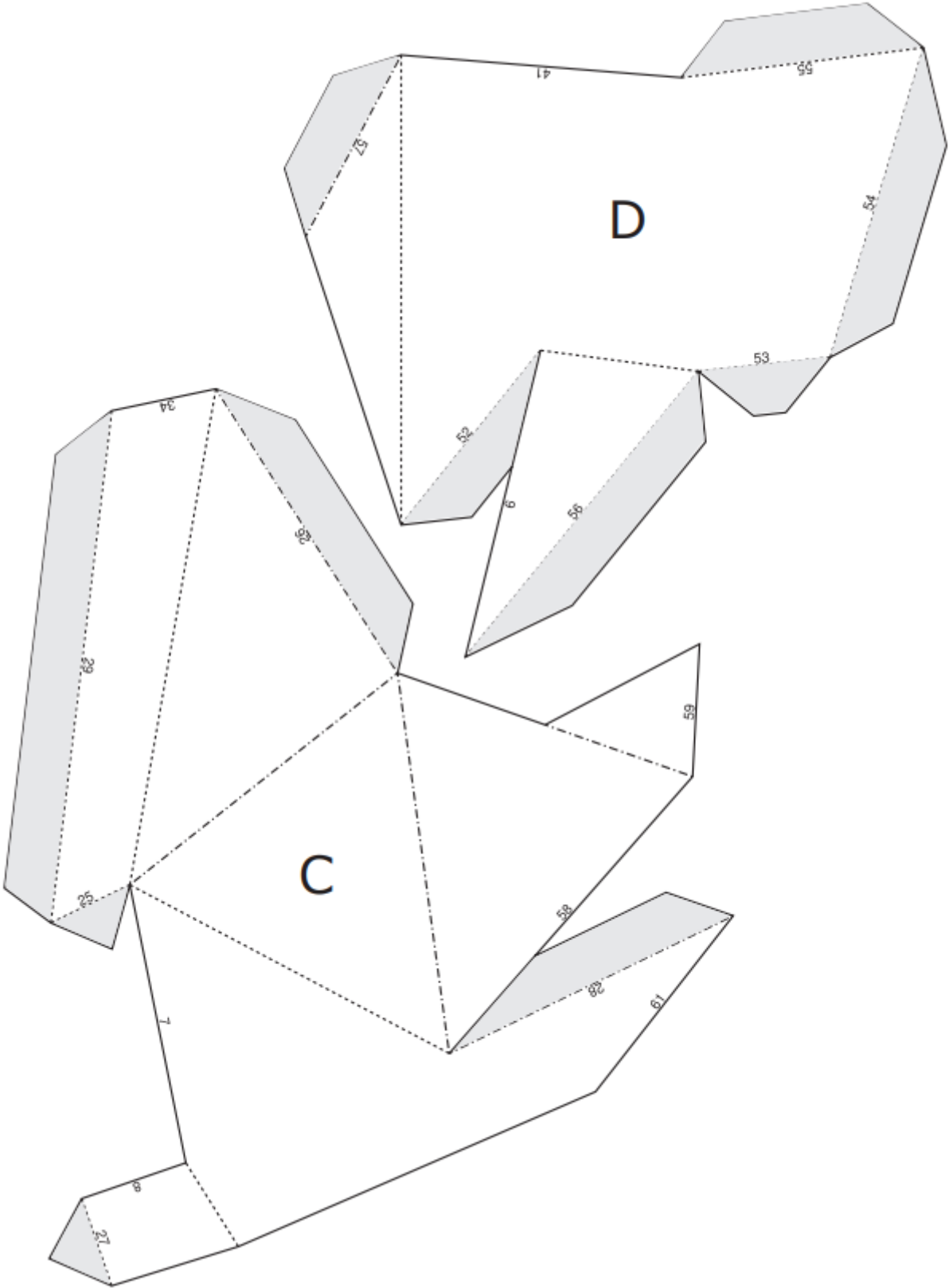

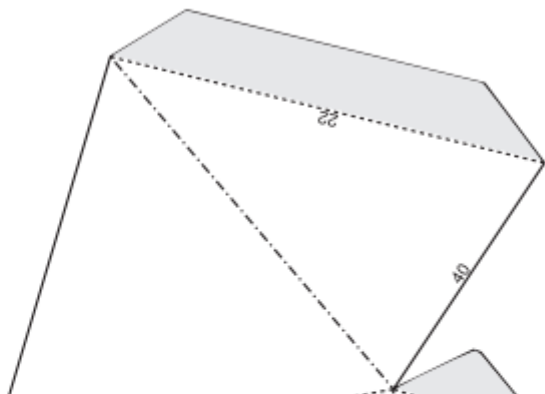
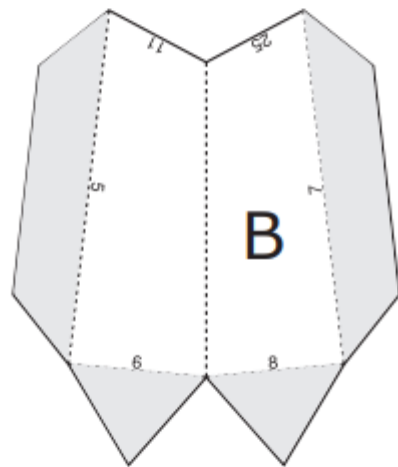
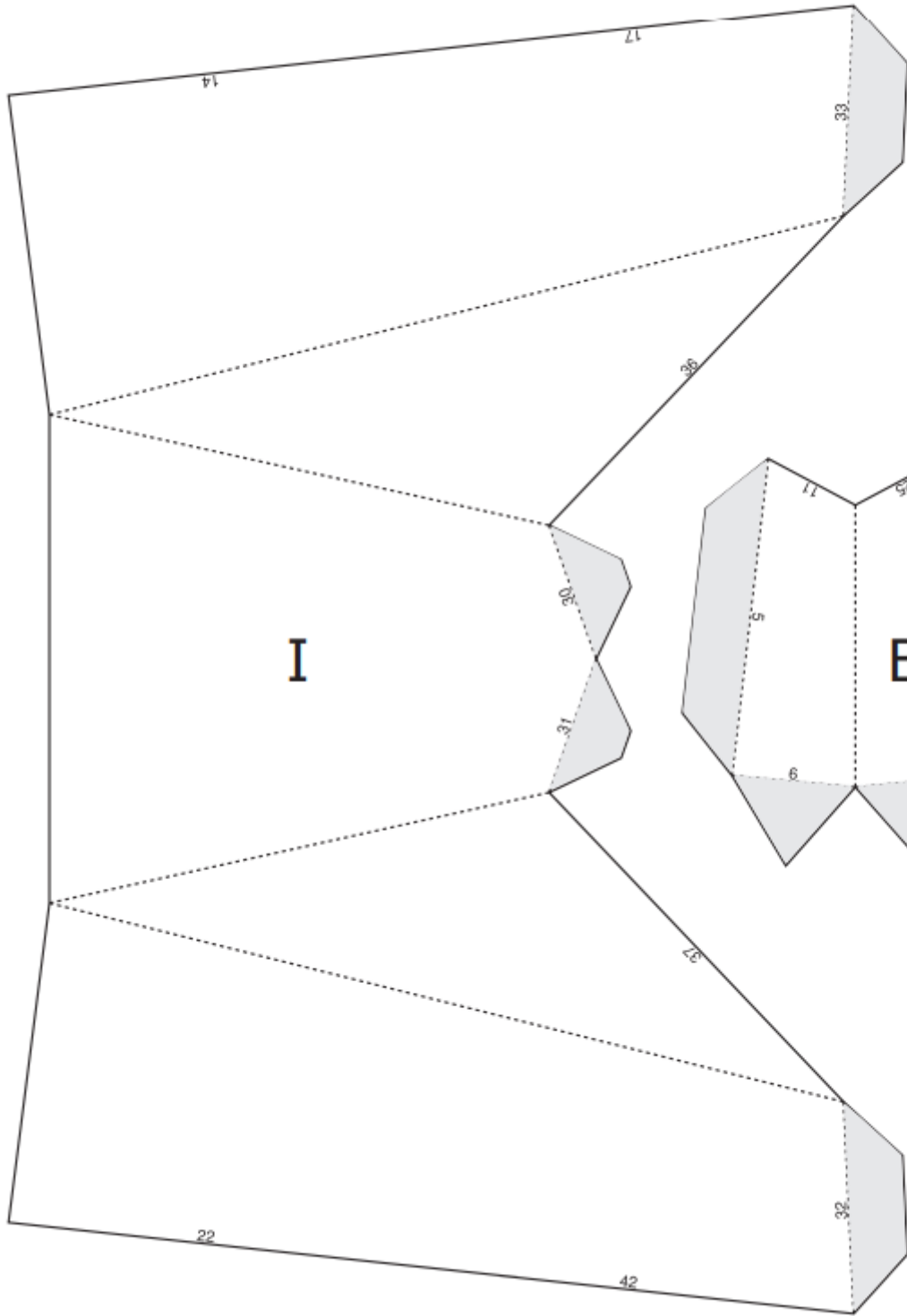

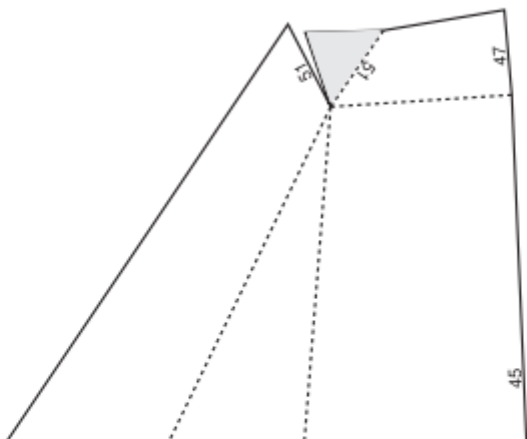
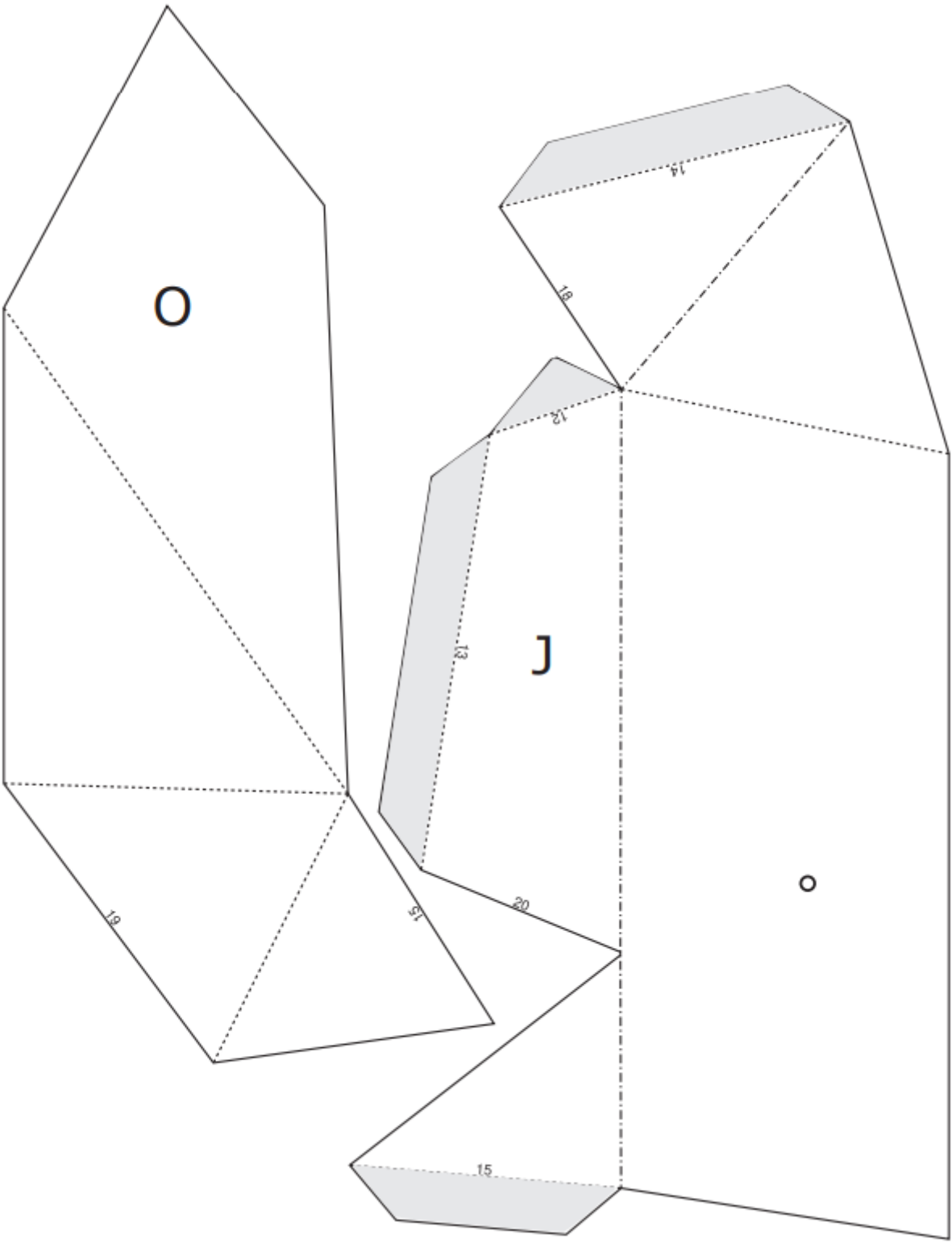

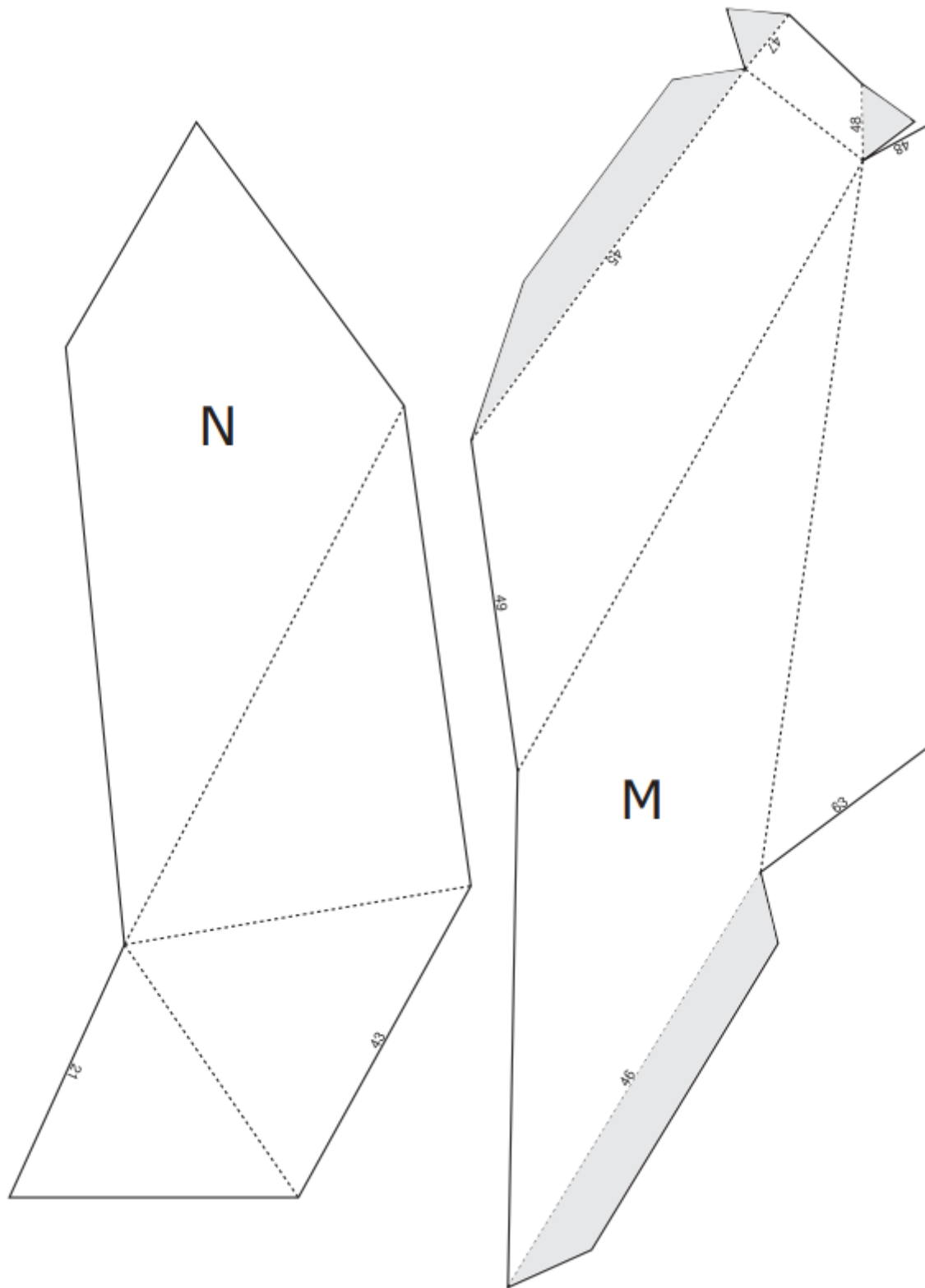

Head Band

To ensure the completed mask fits well you can make a head band and fit it inside of the mask.

Assembly Instructions

1. Cut three strips of card to roughly the dimensions below and join the ends together to form one long strip. We have allowed 50mm overlap for each join.
2. Wrap the band around your head overlapping the open ends and tape together to get a good fit. The band should be snug but not tight.
3. Take the band off your head and tape the front of the band to the front of the inside of the mask. Make sure that the vertical tabs are pointing towards the top of the mask.
4. Tape vertical tabs to the inside of the mask to secure the band in place. You might need to move the tabs around a little until you get it fitting right.

Dirty Water Coolers and Mock Sewage Pipes

More creative ideas for marches or vigils against polluting water companies. Fairly simple to assemble and great props for a wider street theatre idea.



Dirty Water Cooler

Look for a second hand water dispenser on eBay or Gumtree. Fill it with a murky non-toxic liquid and add a very visible company logo. Then offer employees and onlookers a taste of the finest sewage-laced beverage, courtesy of the target water company.



Mock Sewage Pipe

This may require a trip to your local arts & crafts store (or re-cycle one of those hand-chain-tubes). Create some paper & fabric effluent, add a company logo and a shut-off valve for some more effect. Ideally a 'company executive' joins the installation for regular spewing of creative sewage.



Face-in-the-Hole boards

These have been super popular at actions based around beaches and leisure swimming spots.

Lots of people are worried about swimming in the sea and rivers now (and with very good reason)! This light hearted addition to the action will catch people's attention and get them primed for a conversation with you.





Dirty Water Crime Scene

Find instructions for [creating your own Dirty Water Crime Scene here](#).



Making Art with Withy

street art worksheet No.1

making processional sculpture and standards with willow withies, wet-strength acid-free tissue and PVA

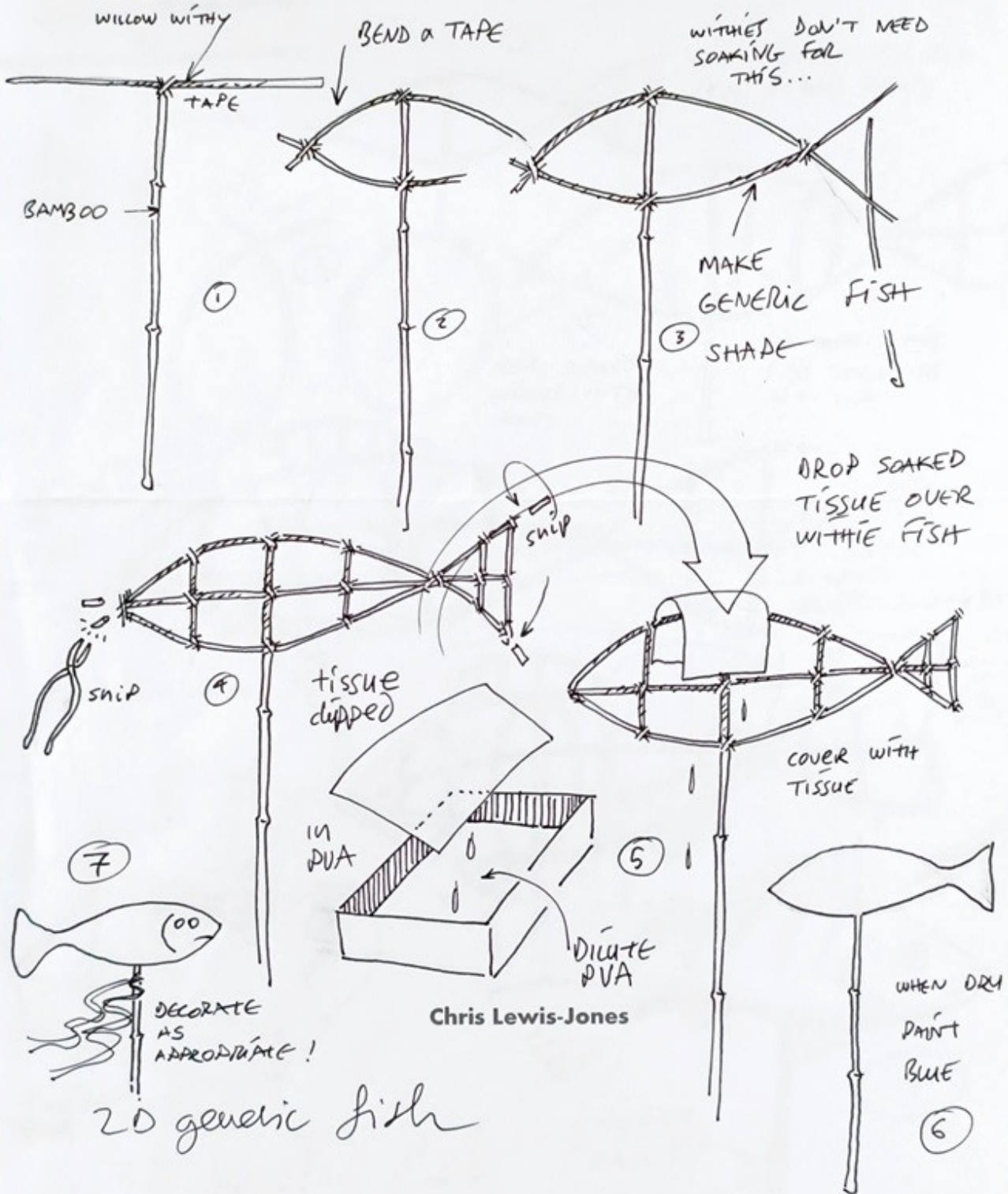

street art worksheet No.2

making processional sculpture and standards with willow withies, wet-strength acid-free tissue and PVA

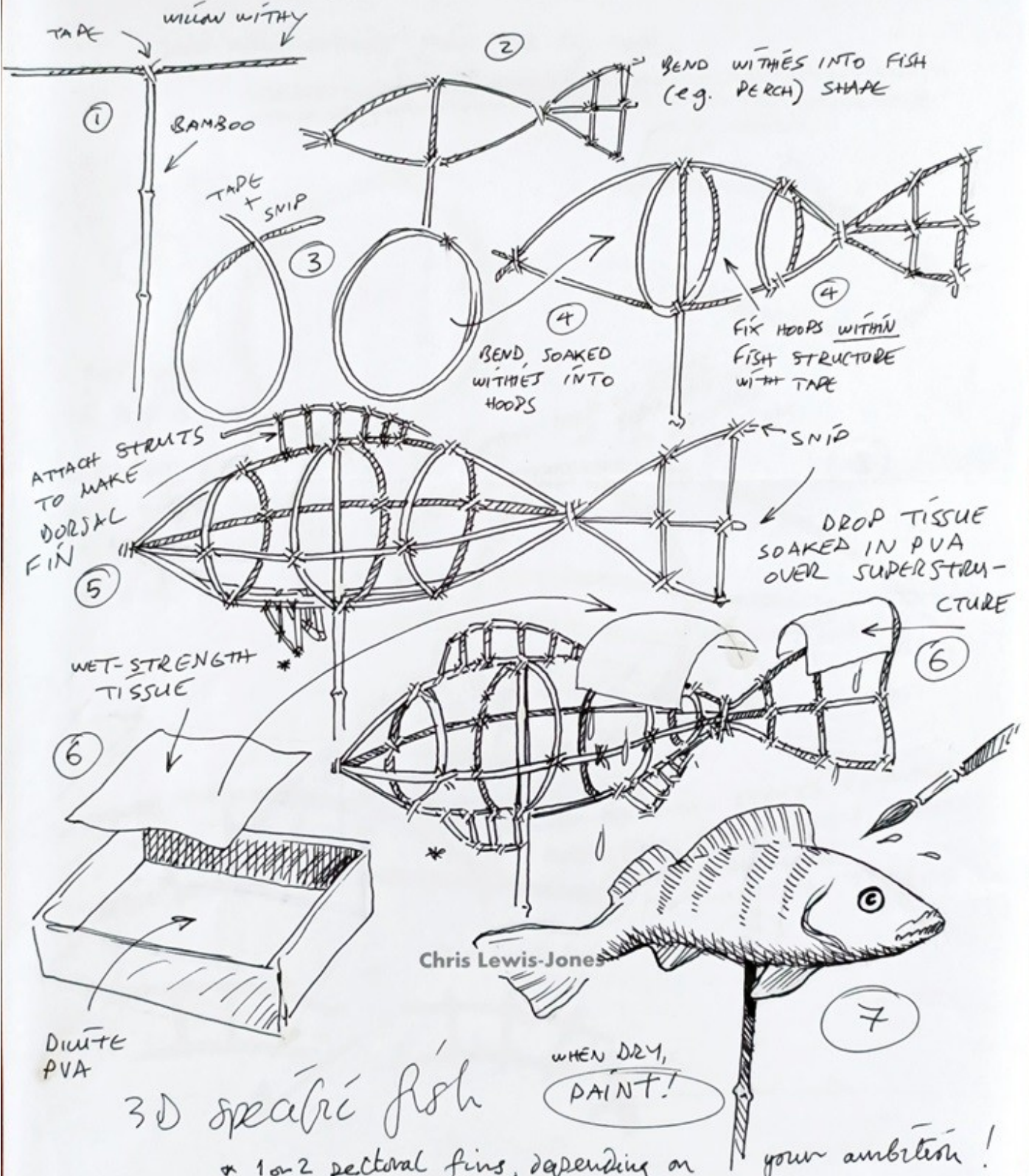

DILUTE PVA

3D spärri fish

WHEN DRY, PAINT!

* 1 or 2 pectoral fins, depending on your ambition!

making processional sculpture and standards with willow withies, wet-strength acid-free tissue and PVA

JOIN WILLOW WITHIES THICK END TO THIN,

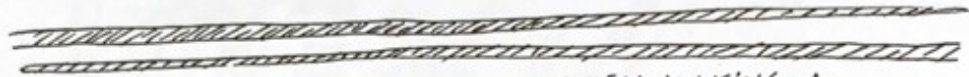

WHEN MAKING A HOOP

3

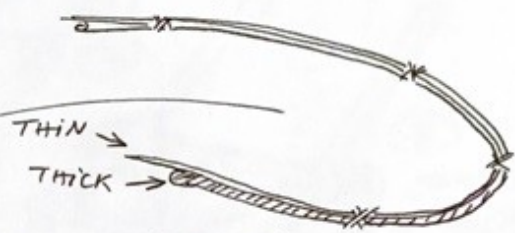
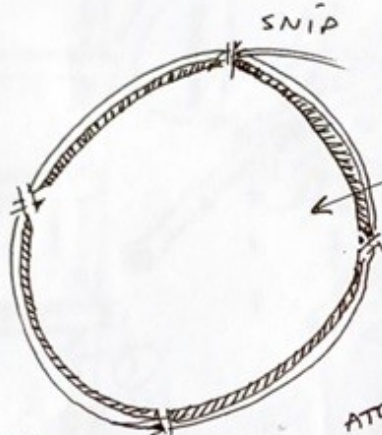

THIN →
THICK →

THE HOOP IS A RIB

A LARGE FISH WILL NEED MORE RIBS, A SMALL FISH - FEWER

ATTACH HOOP ON INSIDE OF SUPERSTRUCTURE TO MAINTAIN TENSION

3

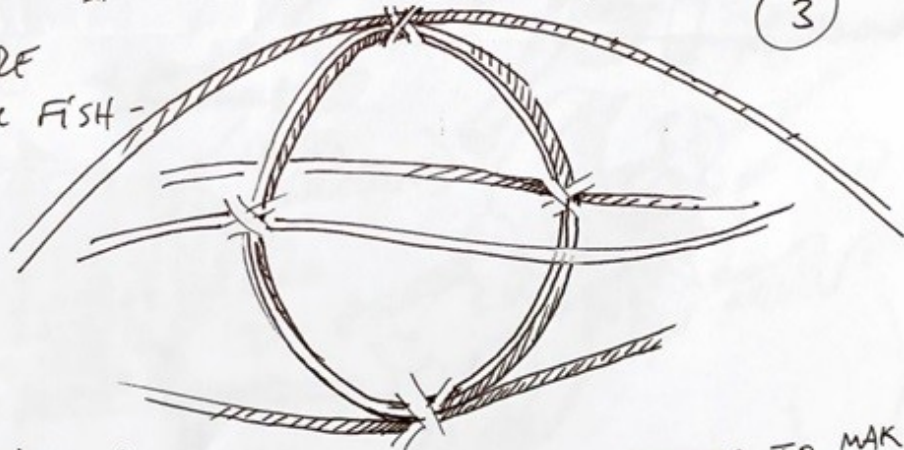

5



WHEN POSITIONING STRUTS TO MAKE DORSAL FIN, PUSH, SLIGHTLY, AGAINST SUPERSTRUCTURE TO MAINTAIN TENSION

5

Chris Lewis-Jones



peak XR SaveOurDerwent

street art worksheet No.5

making processional biers with bamboo and PVA

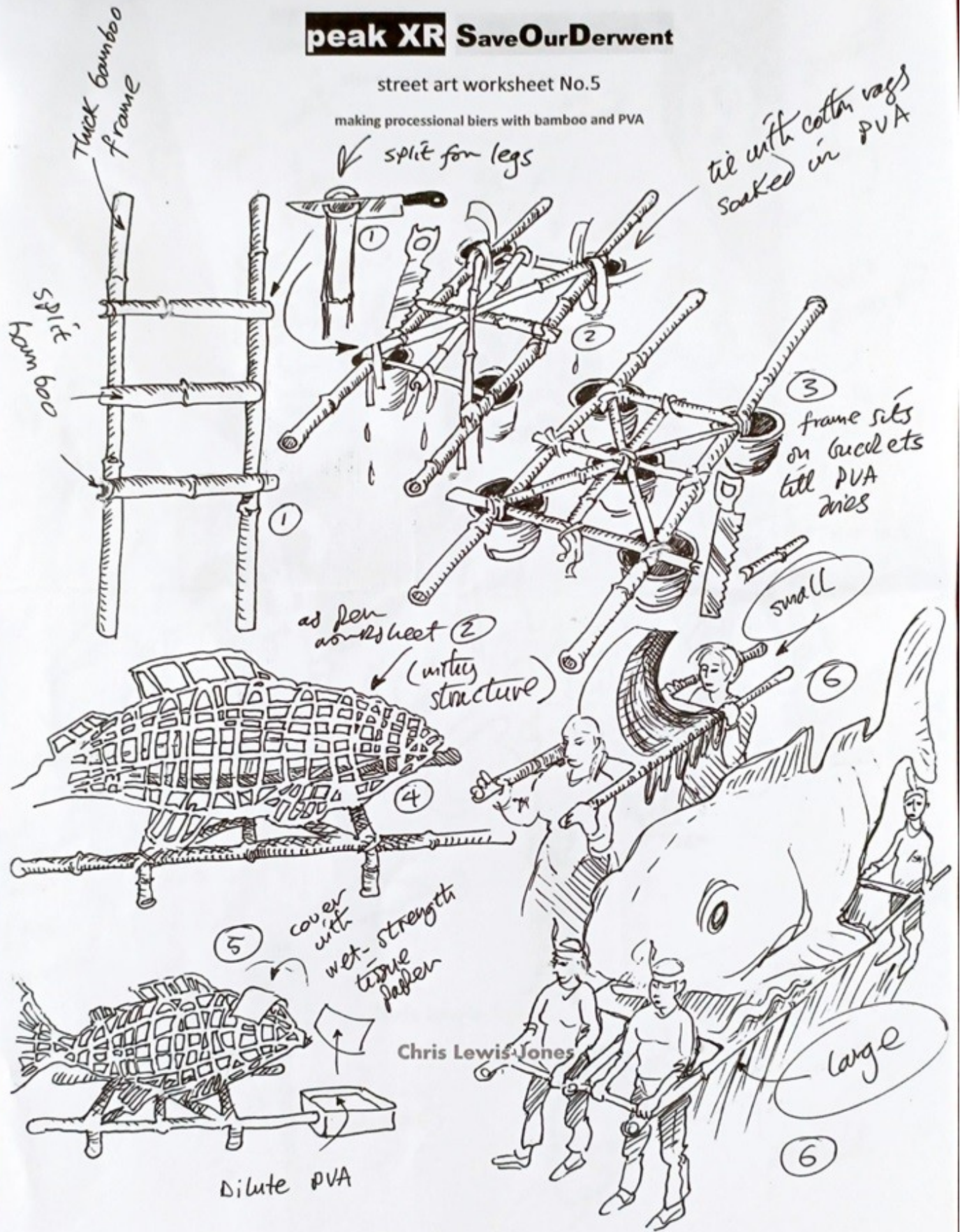

peak XR SaveOurDerwent

street art ideas worksheet

